

Nascom Microcomputers

hardware manual

I/O BOARD

input/output board for
NASCOM micro-
computer systems

NM part number 010-300 issue 1 date 4-3-80

Copyright © 1980 Nascom Microcomputers Ltd., 92 Broad Street,
Chesham, Bucks. HP5 3ED 024-05-75155 tlx 837571

IMPORTANT

I/O BOARD issue 2 PCBs

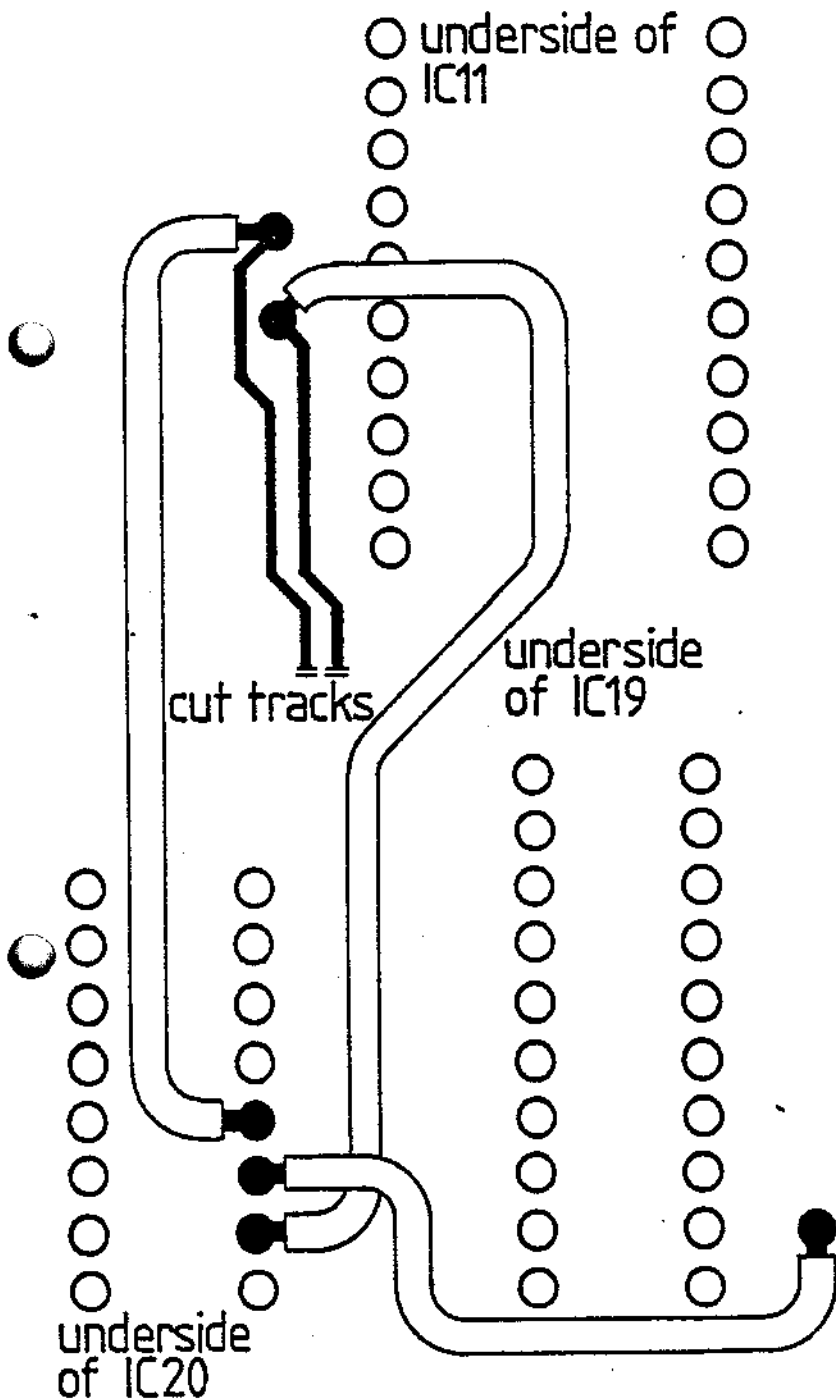

solder side

Do this:

CUTS DONE, NOT LINKS

Tick. ✓ All done.

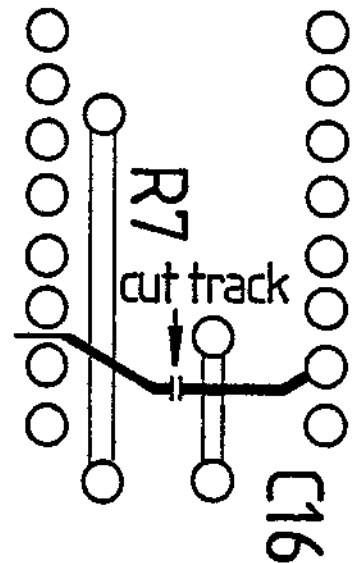

component side

An error has occurred in the manufacture of issue 2 I/O boards; this error affects only the UART option and need not be corrected if this option is not to be used. If, however, a UART is likely to be required, it is recommended that the following modifications be made before the board is constructed:

1. On the component side, cut the track intersecting the position of C16 and connected to pin 15 of IC20.
2. On the solder side, cut two tracks and make links according to the diagram given here. It is essential that insulated wire be used for the links to avoid a short circuit.

It should be emphasised that these modifications must be made if the UART option is to be implemented; if an issue 2 board is used without these changes a bus contention could result, endangering primary devices. We wish to apologise to users for any inconvenience caused by this condition.

nm

Nascom Microcomputers
92 Broad Street Chesham Bucks HP5 3ED
Telephone: (02405) 75151 Telex: 837571

ERRATA

document

I/O BOARD HARDWARE MANUAL

issue

date 3.3.80

NM number

010-300

~~4.2:~~ ADD: The linkblock LBI should be linked only for options present and in use on the board. Addressing for more than one board is given in appendix 8.2.

~~4.5:~~ under '16 pin' ADD: SKT4, SKT5, SKT6

~~4.10:~~ ADD: It is important to make sure that ICs are inserted the right way round; the pin 1 designation (notch or ring) matches the round end of the bar marked on the PCB.

~~7.3:~~ from list of resistors DELETE: Rs 13-23. ADD: Rs 14, 15, 16, 17, 18, 19, 20, 21, 22, 23.

~~7.4:~~ ADD: Diodes are aligned with their anode bands towards the + sign on the PCB.

~~7.2:~~ ADD: The stop bit selection link (S.B.) should now be wired to select a single stop bit or not wired to select two.

~~page 4:~~ to main board parts list ADD: R24-2K2

~~page 8:~~ to parts list ADD: *PROM SPD/1-L(-H).

~~7.7:~~ ADD: Insert PROM SPD/1-L(-H) into position IC20.

~~7.6:~~ note that NAS1-05, BC212 and T39 are equivalent.

it is advisable to make the above corrections to your copy now and to keep this sheet.

ERRATA

document

I/O BOARD HARDWARE MANUAL

issue 1

date 3.3.80

NM number 010-300

Appendix 8.2 (addressing for two boards): to the table shown append:

" This chart shows the recommended addressing for two I/O boards in a system. The locations at which I/O board devices may be addressed are those below A0, ports above A0 being reserved for NASCOM hardware.

Ports already decoded back to the system (e.g. 0-3 if 'IO BLOCK' is set to 4, 0-7 if set to 8) should not be used.

It should be noted that the onboard PIO of NASCOM-1 should be removed if it is present; if this is not done a bus contention, endangering primary devices, may result.

it is advisable to make the
above corrections to your copy
now and to keep this sheet.

contents PAGE

1. Introduction 1
2. Functional specification 1
 - 2.1 general
 - 2.2 references
 - 2.3 functional description
 - 2.4 physical specification
3. Options available 2
4. Construction of main board; MOS precautions 2
 - 4.1 action before construction
 - 4.2 order of construction
 - 4.3 main board parts list
 - 4.4 linkblocks etc.
 - 4.5 IC sockets
 - 4.6 resistors
 - 4.7 capacitors
 - 4.8 option support circuitry
 - 4.9 visual test
 - 4.10 IC insertion
 - 4.11 functional test
5. PIO option 5
 - 5.1 parts list
 - 5.2 linkblocks
 - 5.3 cable socket
 - 5.4 decoder
 - 5.5 PIO
 - 5.6 testing
6. CTC option 7
 - 6.1 parts list
 - 6.2 linkblocks
 - 6.3 header plug
 - 6.4 decoder
 - 6.5 CTC
 - 6.6 testing
7. UART option 8
 - 7.1 parts list
 - 7.2 linkblocks
 - 7.3 resistors
 - 7.4 diodes
 - 7.5 crystal
 - 7.6 transistor
 - 7.7 decoder
 - 7.8 baud rate generator
 - 7.9 UART
 - 7.10 testing

1. Introduction

The NASCOM I/O board is designed to allow the NASCOM microcomputer user the facilities of a Z80 system counter/timer circuit (CTC), a 6402 type UART and three Z80 system parallel input/output controllers (PIOs).

The board may be fitted with any or all of the devices mentioned as and when their capability is required by the user. It is a NASBUS board made to fit standard card frames; access to parallel data lines is given by connectors on the front edge.

This manual instructs the user in construction of the board and in its setting up, programming and use. As each port device may be purchased separately each has a chapter on its addition to the board; reference to these chapters is made where necessary during the construction process.

2. Functional specification

2.1 general

The NASCOM I/O board shall permit the interfacing of a NASCOM microcomputer system to a number of external devices. Six independent 8-bit parallel data ports, one serial data port and a counter/timer shall be supportable by each board.

2.2 references

- 2.2.1 NASBUS functional specification PF/007
- 2.2.2 MOSTEK Z80 system Technical Manual: 3881 PIO
- 2.2.3 MOSTEK Z80 system Technical Manual: 3882 CTC
- 2.2.4 6402 type UART data sheet

2.3 functional description

Each board shall be capable of supporting three MK3881 PIOs, one 6402 UART and one MK3882 CTC. Each device shall, by means of onboard links, be provided with fully decoded address selection.

The board design shall include look-ahead interrupt logic to enable the cascading of a number of similar boards.

2.3.1 PIO

All connections to parallel ports shall be brought to ribbon cable connectors on the edge of the board opposite to the NASBUS connector. +5V and ground lines shall be available on the same connector.

The interrupt daisy chain shall be preserved even if the board is not fully populated.

2.3.2 CTC

All clock outputs and trigger inputs shall be brought to a 16 pin DIL socket, which shall also carry the CPU clock as a selectable source for the counters. The CTC shall be included in the interrupt structure at the position of highest priority.

2.3.3 UART

This device shall provide RS232 and 20mA current loop serial interfaces. 7 or 8 bit characters shall be selectable. A crystal-controlled monolithic device shall

make the following baud rate signals available for clocking the UART: 110, 150, 200, 300, 600, 1200, 1800, 2400, 3600, 4800, 7200 and 9600 baud.

The UART shall be excluded from the interrupt structure to simplify programming.

2.4 physical specification

The board shall conform to NASBUS specification (PF/007).

3. Options available

Each I/O board is supplied without its primary devices, each of which may be purchased separately. The component packs available are as follows:

PIO option (up to three)

MK3881 PIO

8131 decoder device

Ribbon cable, plug and socket

UART option (one only)

6402 UART and 8131 decoder device

MC14411 baud rate generator

1.8432MHz crystal

discrete components for serial interfaces

CTC option (one only)

MK3882 CTC

8131 decoder device

The main board kit contains all other components, including IC sockets for optional devices. No documentation is supplied with component packs; this manual should be retained for information on fitting options.

Parts should be checked against the formal parts lists given in chapters 4,5,6 and 7 before construction commences.

4. Construction of main board

The constructor is recommended to make reference to the Construction Manual for his system computer if in any doubt about techniques or materials required to construct this type of equipment. It is assumed otherwise that familiarity with this type of work has already been gained in the construction of the system computer. It is, however, necessary to stress the importance of precautionary handling of MOS devices; despite the controversial nature of this topic it is felt that the following precautions at least should be taken to avoid the

frustration and loss of time that static damage to primary devices could cause:

- a). do not handle MOS devices by their pins; do not leave them out of their packing or unpack them before they are needed. Resist the temptation to try the fit of their sockets.
- b). do not solder on tracks connected to MOS devices; avoid, if possible, soldering on a populated board at all. Ensure that a ceramic-shafted low-leakage soldering iron is used under any circumstances.
- c). Be careful fitting devices into their sockets; it is recommended that the chip be inserted first at one end, the pins being eased into the socket along its length. Attempting to insert all the pins at once is unlikely to work. Removal of ICs is more likely to cause damage than is insertion; ensure a clean extraction if this becomes necessary.

4.1 action before construction

Unpack the kit of parts. ICs packed in antistatic tubes may normally be identified without removal; if not, handle them with care while identifying them. Check all parts with the formal parts lists. If option packs are present, check their contents similarly. Note that all option packs contain MOS devices; the main board kit does not.

If any parts are missing, particularly parts of this manual, arrange their supply before proceeding.

Arrange all components to hand in the preferred working environment and carry on.

4.2 order of construction

It is recommended that all resistors, capacitors, links, diodes, transistors and crystals be fitted before ICs are inserted. If options are being added, they should be constructed to the point of IC insertion before any devices are fitted.

If an option is being added after the board has been completed and put into use, it is not essential to remove the ICs from the board before adding the new parts; provided that the recommended type of soldering iron is used, no harm should come to the rest of the board. The sequence of assembly given in the option chapter should, however, be followed with reasonable accuracy.

Diagrams showing the wiring of linkblocks and header plugs are given at the appropriate points in the construction sequence; most show the wiring patterns necessary to match the board with addressing information given elsewhere in this manual. It is possible to wire boards to function in different manners; an appendix on addressing for two-board operation is included.

The link block LBI should be linked only for options present and in use on the board. Addressing for more than one board is given in appendix 8.2

4.3 main board parts list

circuit ref.	value/type	circuit ref.	value/type
R1	4K7	R2	10K
R4	330R	R5	330R
R6	330R	R7	330R
R8	10K	R12	1K
R13	4K7	R24	2K2
C1	2u2, 10V tantalum electrolytic		
Cs 2-19	10nF disc ceramic decoupler		
IC6	74LS32	IC7	74LS245
IC14	7417	IC15	7417
IC16	7406	IC17	74LS00
IC18	74LS367	IC19	81LS97
IC21	8131		

also supplied: 4x 40 pin IC sockets, 1x 28 pin, 1x24 pin, 2x20 pin, 11x16 pin and 5x14 pin ditto
 printed circuit board
 24 inches of link wire
 a 77 way edge connector

4.4 Using a 1" length of link wire, link points 4 and C on link "IO BLOCK" for operation with NASCOM-1; for operation with NASCOM-2 link 8 and C. ✓

4.5 Insert and solder IC sockets as follows:

- 14 pin: IC6, IC14, IC15, IC16, IC17
- 16 pin: ICs 1-5, IC18, IC20, IC21, SKT 4, SKT 5, SKT 6
- 20 pin: IC7, IC19
- 24 pin: IC13
- 28 pin: IC8
- 40 pin: IC9, IC10, IC11, IC12.

Note the position of pin 1 in each case.

4.6 Insert and solder resistors R1, R2, Rs 4-8, R12, R13 and R24 with reference to the parts list.

4.7 Insert and solder capacitors C1 and Cs 2-19; C1 is a tantalum electrolytic and must be correctly orientated with the + sign on the PCB thus:

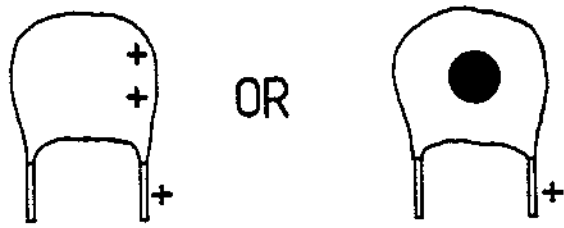

4.8 At this stage, before ICs are inserted into their sockets, proceed to construct the selected options to the point of IC insertion.

4.9 Check all soldering for dry joints, solder bridges and unsoldered connections. Examine the board closely under an intense light.

4.10 Insert ICs as follows:

IC6: ~~74LS32~~ IC7: ~~74LS245~~ IC14: ~~7417~~ IC15: 7417 IC16: 7406
 IC17: ~~74LS00~~ IC18: ~~74LS367~~ IC19: 81LS98 ~~IC21: 8131~~

At this stage the ICs for the selected options should be fitted according to option instructions.

Pin 1 is the end of board marking.

4.11 Plug the board into the NASCOM system and modify decoding accordingly (refer to NASCOM -1 or -2 manuals). Ensure that the system functions correctly. On NASCOM-1 the onboard PIO will now be disabled.

COMPLETED TO HERE.

5. PIO option

Up to three PIOs may be used; all are set up identically except for their selection linkblocks, which are shown below.

5.1 parts list

circuit ref.	value/type
IC9/10/11	MK3881-4; 280-PIO
IC ^F 2/4/5	8131
SK1/2/3	CAD26 SP100-230-455
cable	26 way cable/skt assembly

5.2 Referring to the diagrams below, wire linkblocks as required.

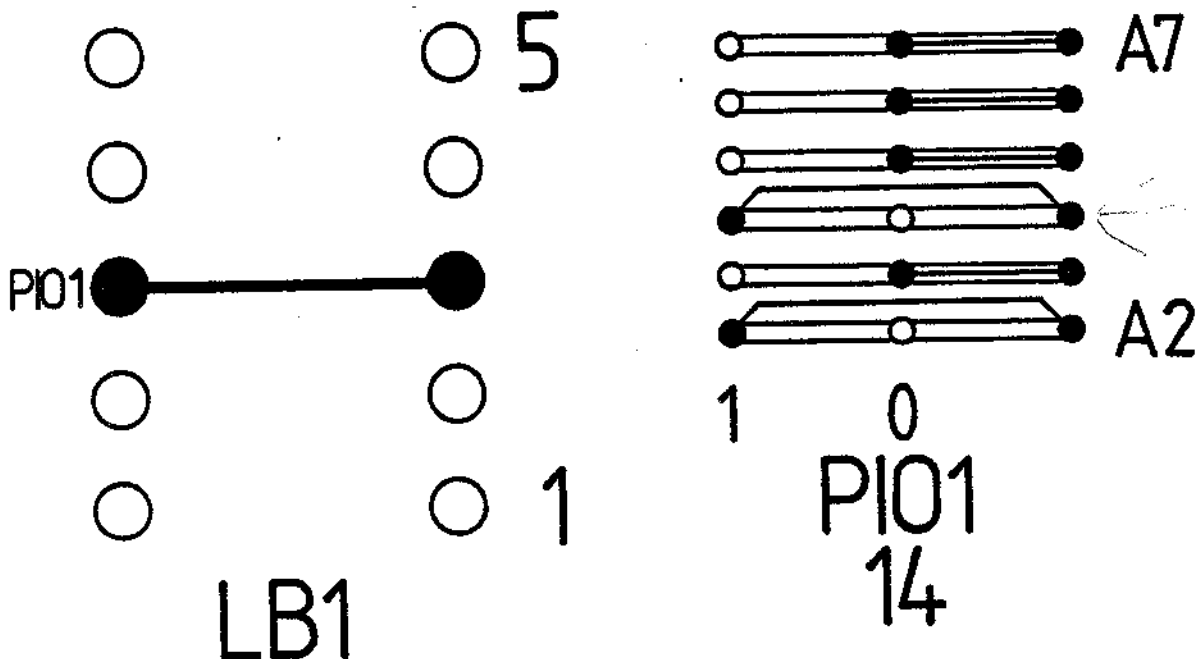

4 100
 5 101
 6
 7

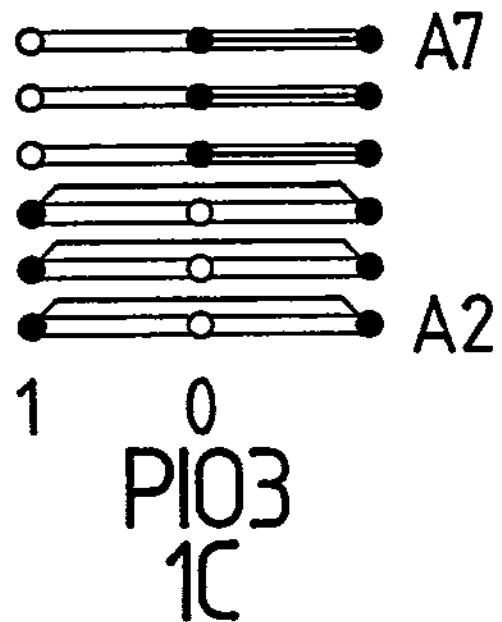
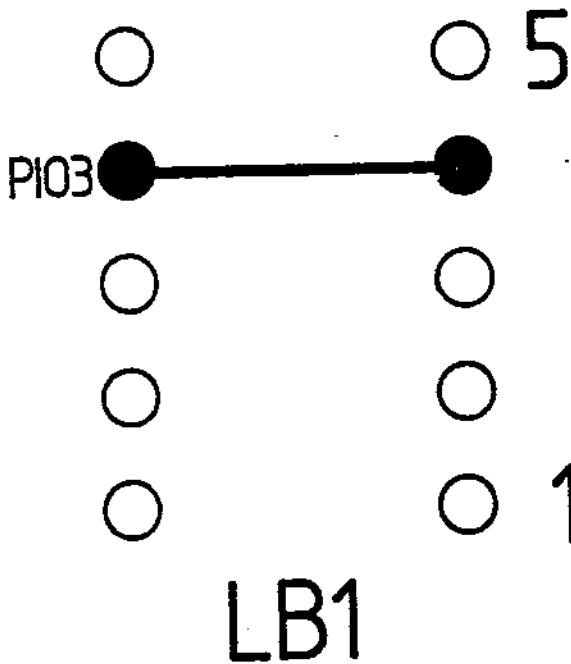
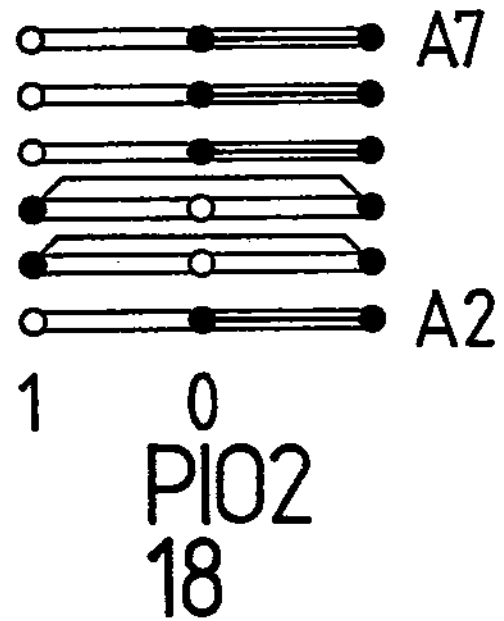
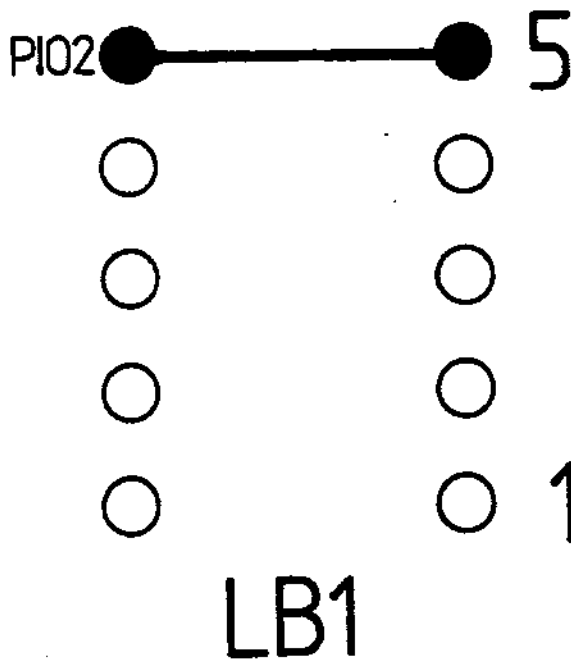

5.3 Insert and solder Circuit Assembly CAD26 SP100-230-455 socket into position as follows: SKT1 for IC9, SKT2 for IC10, SKT3 for IC11.

5.4 Insert an 8131 decode for each PIO as follows: as IC5 for IC11, as IC2 for IC10 and as IC4 for IC9.

5.5 Insert MK3881 PIO(s) into sockets IC9, IC10 or IC11 as required (MOS).

PIO	IC no.	CA skt. no.	8131 IC no.
1	11	1	5
2	10	2	2
3	9	3	4

5.6 Referring to the PIO Technical Manual, check the function of the PIO(s).

6. CTC option

6.1 parts list

circuit ref.	type/value
IC8	MK3882-4; Z80-CTC
IC1	8131
SKT6	16 pin DIL header

6.2 Referring to the diagram below, wire linkblocks as required.

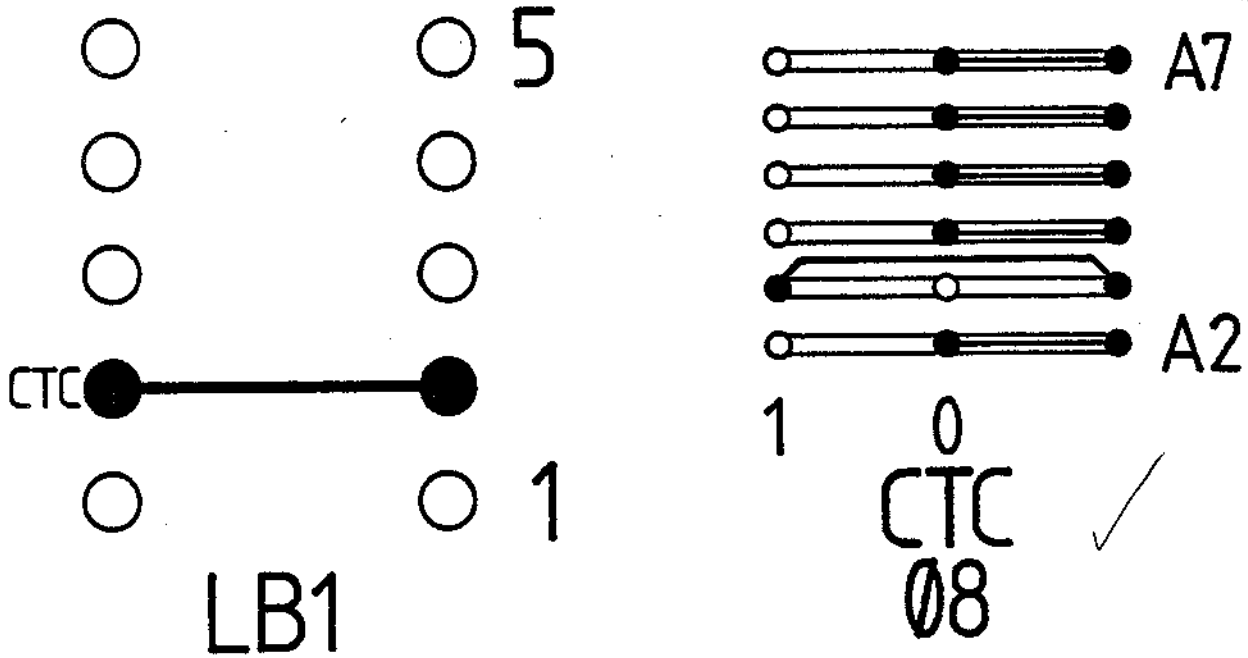

6.3 Referring to the diagram below and to the CTC technical manual, wire the header plug for SKT6 to provide the required inputs and outputs for the CTC. Plug the header into SKT6.

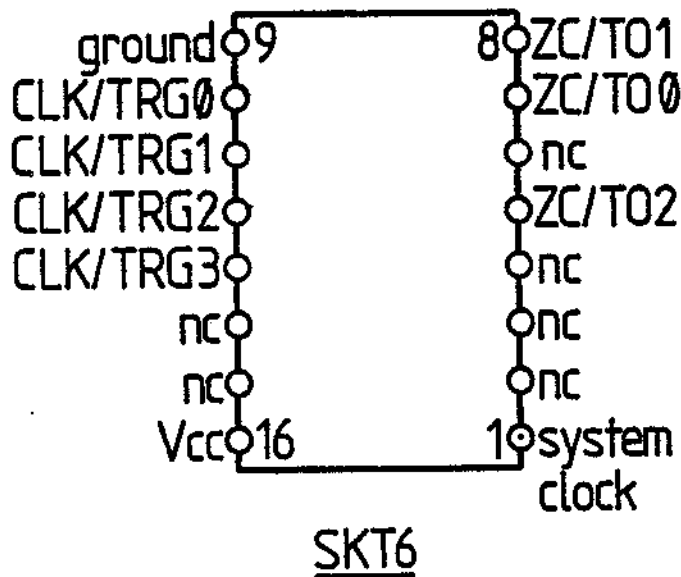

6.4 Insert 8131 decoder into position IC1.

6.5 Insert CTC into position IC8 (MOS).

6.6 Referring to the CTC technical manual, check the functioning of the CTC.

7. UART option

7.1 parts list

circuit ref.	value/type	circuit ref.	value/type
IC12	6402/8017 UART	TR1	NAS1-05
IC13	MC14411 BRG	XTAL	1.8432 MHz crystal
IC3	8131	D1	1N4148
IC20	7603/5610 PROM*	D2	1N4148
R16	470R	R23	560R
R22	1K	R19	2K2
R20	2K7	R _s 21, 14	4K7
R _s 9, 10, 11, 15, 17, 18	10K	R3	10M
R _s 25, 26, 27	10K		
SKTs 4,5	16 pin header		

* PROM SPD/1-L(-H)

also supplied: KWIKSTIK PAD for crystal

7.2 Wire linkblocks as shown below.

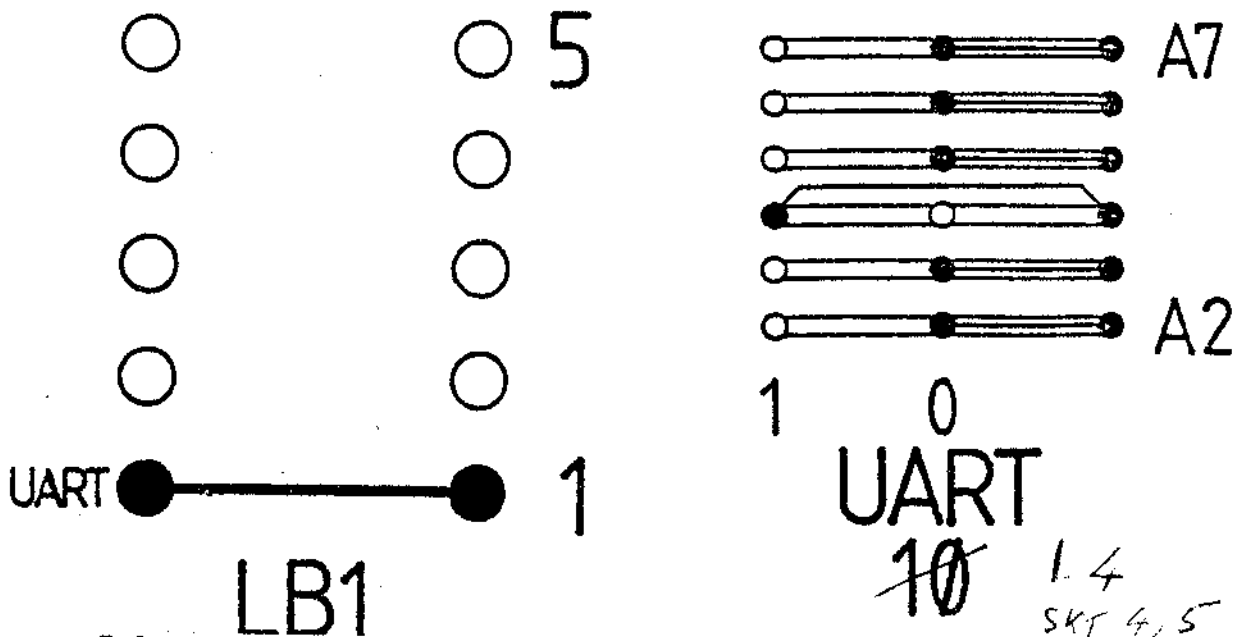

7.2: ADD: The stop bit selection link (S.B.) should now be wired to select a single stop bit or not wired to select two.

7.3 Insert and solder resistors R3, R_s 9-11, R_s 14-23 and R_s 25-27.

7.4 Insert and solder diodes D1 and D2.

7.4: ADD: Diodes are aligned with their anode bands towards the + sign on the PCB.

7.5 Solder both leads of the crystal through a right angle 3mm from the case; mount the crystal on the board with the KWIKSTIK PAD supplied and solder in its leads.

7.6 Insert and solder transistor TR1; its orientation with the PCB is shown below.

Note NAS1-05, BC212, T39 are equivalent

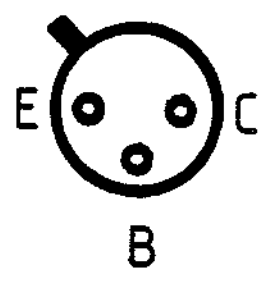
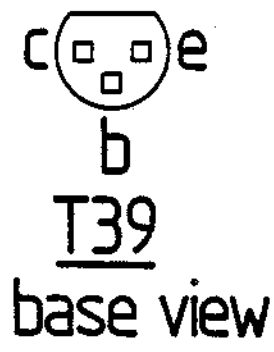

- 7.7 Insert 8131 decoder into position IC3. Insert PROM SPD/1-L(-H) into IC 20 position.
- 7.8 Insert MC14411 baud rate generator (MOS) into position IC13.
- 7.9 Insert 6402 UART (MOS) into position IC12.
- 7.10 Referring to the UART data sheet, test this device's functioning.
- 7.11 Connection may now be made to the RS232 interface; its socket is shown below. The interface may be set for transmission and reception baud rates by linking pins 14 and 15 of socket 5 with the appropriate pins; see diagram below.

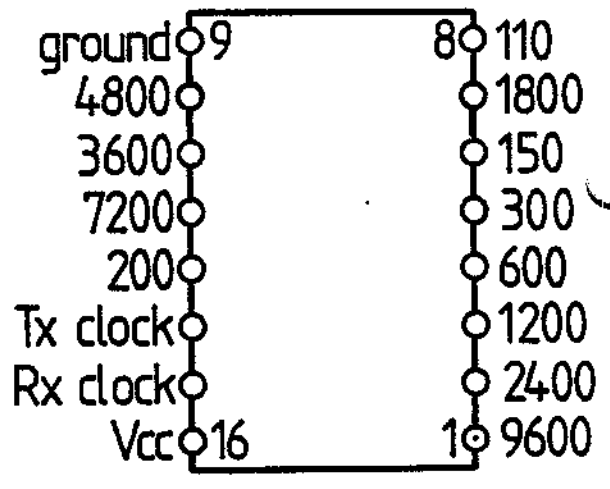
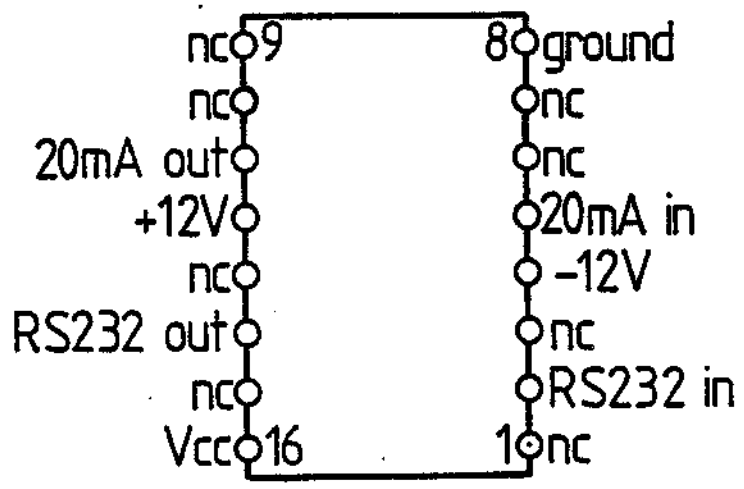

8.1 PIO cable assignments

<u>core no.</u>	<u>colour</u>	<u>assignment</u>
1	brown	B5
2	red	B4
3	orange	B6
4	yellow	B3
5	green	B7
6	blue	B2
7	violet	<u>ARDY</u>
8	grey	<u>B1</u>
9	white	<u>BSTB</u>
10	black	<u>B0</u>
11	brown	<u>ASTB</u>
12	red	<u>BRDY</u>
13	orange	A0
14	yellow	nc
15	green	A1
16	blue	ground
17	violet	A2
18	grey	ground
19	white	A3
20	black	+5v
21	brown	A4
22	red	+5v
23	orange	A5
24	yellow	A7
25	green	A6
26	blue	nc

10
800
500
300
100
200
400
600

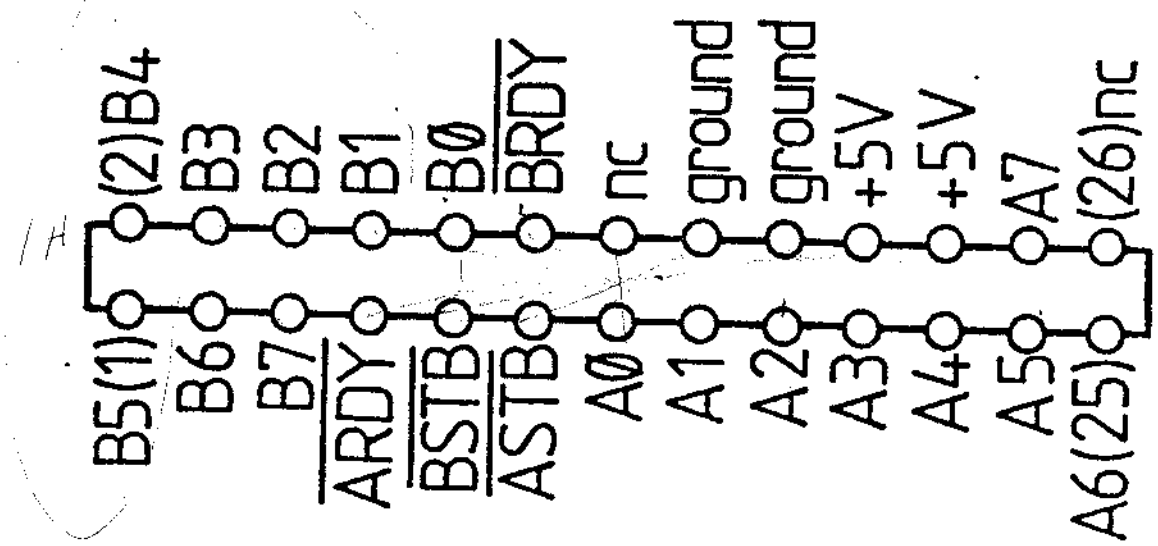

SKTs 1,2,3

8.2 addressing for two boards

Hex			A7	A6	A5	A4	A3	A2
08	CTC no.1 ✓	PLUG HAS PIN 1 → 10 SHORT	0	0	0	0	1	0
09								
0A								
0B								
0C	CTC no.2		0	0	0	0	1	1
0D								
0E								
0F								
10								
11	UART no. 1	data	0	0	0	1	0	0
12		status						
13								
14	PIO no.1	14H A data	0	0	0	0	0	1
15		15H B data						
16		16H A control						
17		17H B control						
18	PIO no. 2	A data	0	0	0	1	1	0
19		B data						
1A		A control						
1B		B control						
1C	PIO no. 3	A data	0	0	0	1	1	1
1D		B data						
1E		A control						
1F		B control						
20								
21	UART no. 2	data	0	0	1	0	0	0
22		status						
23								
24	PIO no. 4	A data	0	0	1	0	0	1
25		B data						
26		A control						
27		B control						
28	PIO no. 5	A data	0	0	1	0	1	0
29		B data						
2A		A control						
2B		B control						
2C	PIO no. 6	A data	0	0	1	0	1	1
2D		B data						
2E		A control						
2F		B control						

OVER

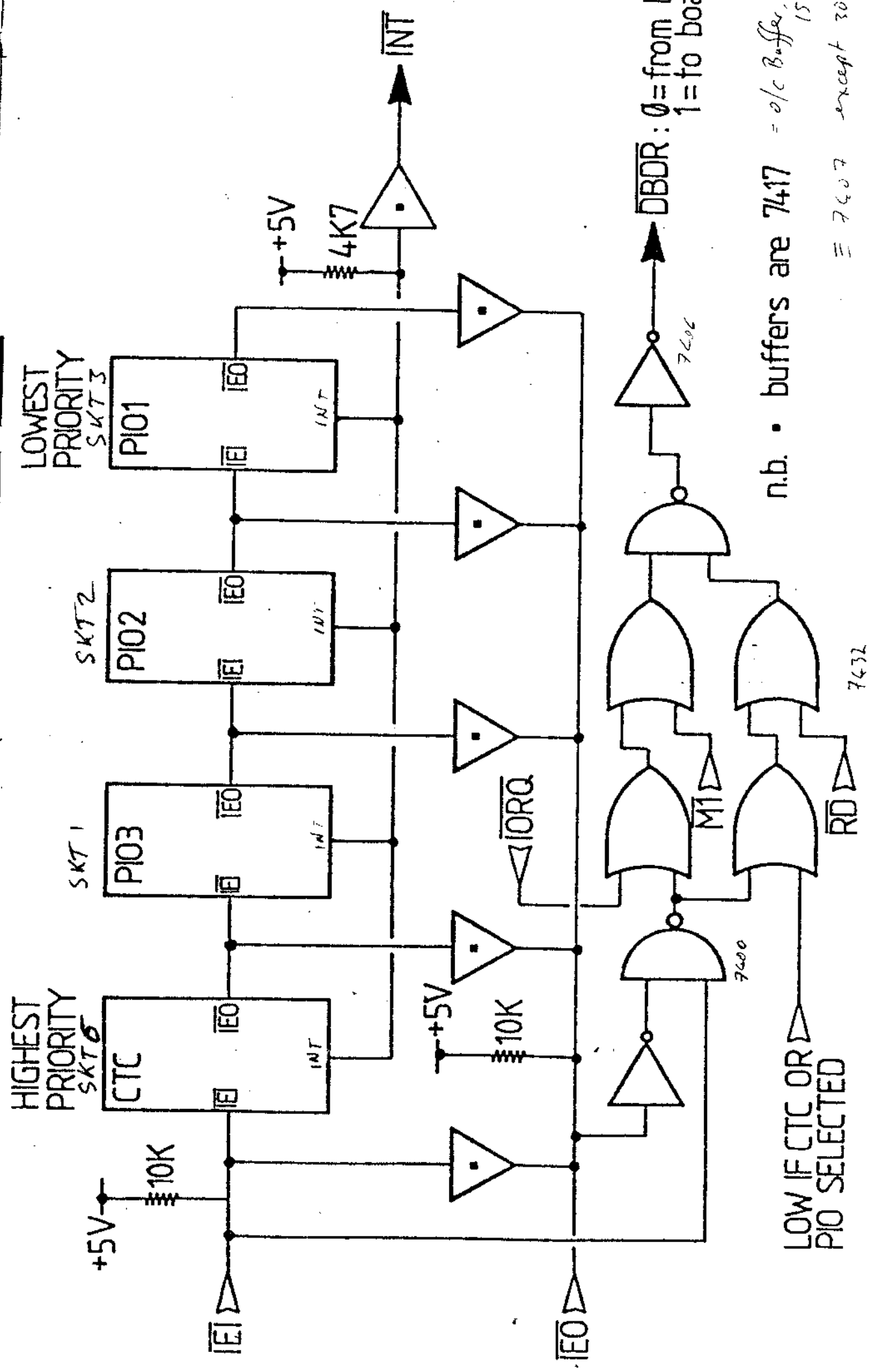

n.b. • buffers are 7417 = o/c Buffer, HiVol/15V o/p
 ≡ 7407 except 30V o/p

LOW IF CTC OR PIO SELECTED